

CRS-120

100...140W SINGLE OUTPUT DC/DC CONVERTERS

GENERAL FEATURES:

- High input-output isolation
- Standard size Eurocard 3U
- Adjustable output voltage
- Remote sensing
- Input voltage OK LED
- Output voltage presence LED
- Remote inhibit
- Efficiency up to 89%



	12Vin 9V ... 15V	24Vin 18V ... 30V	48Vin 36V ... 72V	72Vin 50,4V ... 90V	110Vin 77V ... 144V	220Vin 165V ... 275V
5Vout	CRS-120-6761 100W	CRS-120-6765 100W	CRS-120-6769 100W	CRS-120-6773 100W	CRS-120-6777 100W	CRS-120-6781 100W
12Vout	CRS-120-6762 100W	CRS-120-6766 120W	CRS-120-6770 120W	CRS-120-6774 120W	CRS-120-6778 120W	CRS-120-6782 120W
24Vout	CRS-120-6763 120W	CRS-120-6767 120W	CRS-120-6771 140W	CRS-120-6775 140W	CRS-120-6779 140W	CRS-120-6783 140W
48Vout	CRS-120-6764 120W	CRS-120-6768 120W	CRS-120-6772 140W	CRS-120-6776 140W	CRS-120-6780 140W	CRS-120-6784 140W



INPUT	
Input voltage range	See table
Input undervoltage shutdown	55% to 60% V_i nom
Maximum allowed input ripple	5% V_{in} nom (V_{rms} at 100Hz)
OUTPUT	
Output voltage	See table
Output voltage adjustment	-10% ... +15% V_o nom -10% ... +25% V_o nom for 12V output models
Line regulation ($I_o = \text{nom}$)	< 0,2 % ($I_o = \text{nom}$)
Load regulation ($V_{in} = \text{nom}$)	< 0,2 % ($V_{in} = \text{nom}$; $I_o: 0...100\%$)
Ripple	< 50 mVpp
Noise (BW = 20MHz)	< 100 mVpp
ENVIRONMENTAL	
Storage temperature	-40°C ... 85°C
Operating temperature range at $I_o = 100\%$	-25°C ... 60°C (-40°C ... 60°C, see note-1)
Operating temperature range at $I_o = 50\%$	-25°C ... 80°C (-40°C ... 80°C, see note-1)
Maximum Relative humidity	95% with no condensation
MTBF	500.000h @ 40°C according to IEC61709
EMC	
Emission	EN61000-6-3
Immunity	EN61000-6-2
SAFETY	
Safety	EN60950-1, EN62368-1
Dielectric strength Input / Output	3000Vac, 4200Vdc 1min.
Dielectric strength Input / Earth	1500Vac, 2100Vdc 1min.
Dielectric strength Output / Earth	1500Vac, 2100Vdc 1min.
MECHANICAL	
Approximate weight	430g
Dimensions	100 x 160 x 38.5mm
CONTROL	
Remote inhibit range	5V ... 24V
Remote sense	< 0.3V per pole
PROTECTIONS	
Against overloads and short-circuits	Current limiting
Against reverse input voltage.	Input fuse
Against input under-voltage.	Under-voltage lock-out
Against Input over-currents	Input fuse

Note-1: The unit can start up and work at an ambient temperature of -40°C with the following restrictions:

- Do not handle the connection terminals below -25°C.
- The output ripple can rise up to 150mVpp at -40°C

ORDERING CODES

Part Number	Power [W]	Input [V]	Input range [V]	Output [V]	Output current [A]	Efficiency [%]
CRS-120-6761	100	12	9 - 15	5	20	78
CRS-120-6762	100	12	9 - 15	12	8,3	83
CRS-120-6763	120	12	9 - 15	24	5	84
CRS-120-6764	120	12	9 - 15	48	2,5	85
CRS-120-6765	100	24	18 - 30	5	20	78
CRS-120-6766	120	24	18 - 30	12	10	83
CRS-120-6767	120	24	18 - 30	24	5	84
CRS-120-6768	120	24	18 - 30	48	2.5	85
CRS-120-6769	100	48	36 - 72	5	20	79
CRS-120-6770	120	48	36 - 72	12	10	84
CRS-120-6771	140	48	36 - 72	24	5,83	86
CRS-120-6772	140	48	36 - 72	48	2,92	88
CRS-120-6773	100	72	50,4 - 90	5	20	79
CRS-120-6774	120	72	50,4 - 90	12	10	84
CRS-120-6775	140	72	50,4 - 90	24	5,83	86
CRS-120-6776	140	72	50,4 - 90	48	2,92	88
CRS-120-6777	100	110	77 - 144	5	36	80
CRS-120-6778	120	110	77 - 144	12	20	85
CRS-120-6779	140	110	77 - 144	24	5,83	87
CRS-120-6780	140	110	77 - 144	48	2,92	89
CRS-120-6781	100	220	156 - 275	5	20	80
CRS-120-6782	120	220	156 - 275	12	10	85
CRS-120-6783	140	220	156 - 275	24	5,83	87
CRS-120-6784	140	220	156 - 275	48	2,92	89

CRS-120-67__-__

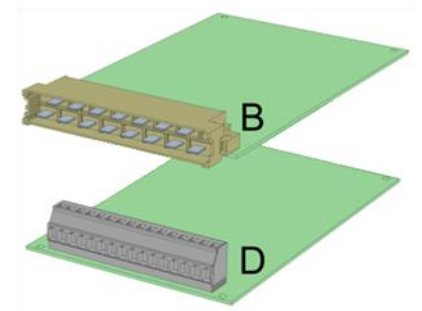
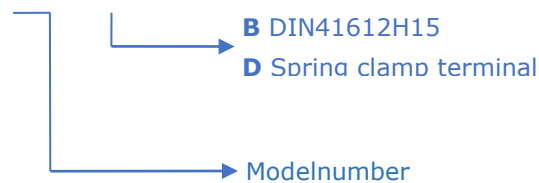

Accessories must be ordered in a separated order line

LOCKS DIAGRAM

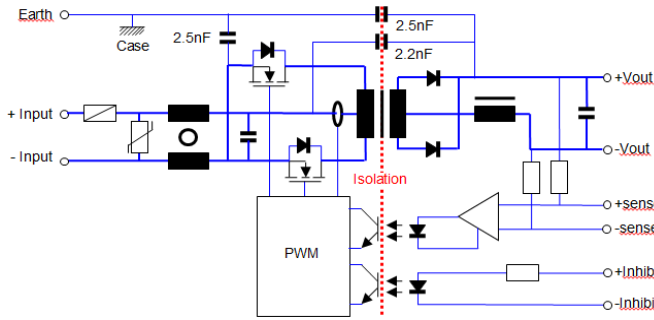

CONNECTIONS

Connector DIN41612H15 (Max. 12A / terminal)

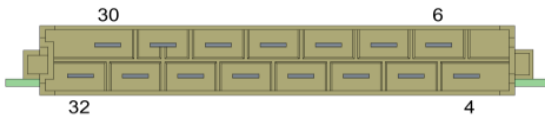

Spring clamp terminals (Max. 12A / terminal)

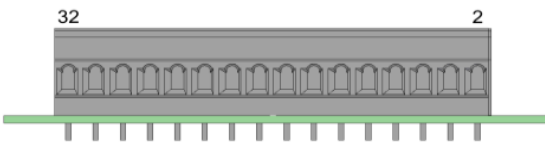

Pinout	
+Input	8,10
-Input	4,6, (2)
Earth	16
+Output	26,28,30
-Output	20,22,24
+Sense	32
-Sense	18
+Inhibit	14
-Inhibit	12

TYPICAL OUTPUT CHARACTERISTIC

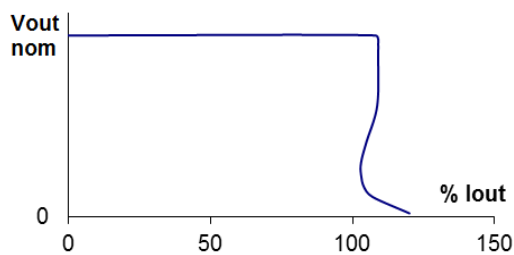

POWER DERATING vs AMBIENT TEMP.

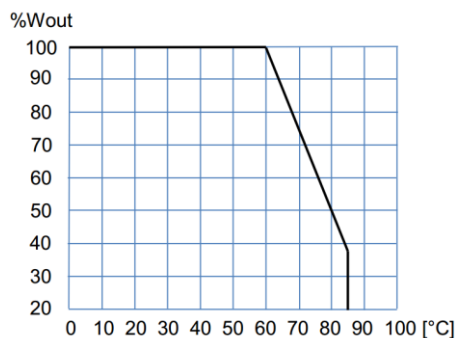

DESCRIPTION

The CRS-120 series consists of DC-DC converters, with a galvanic isolation between input and output. The converters operate at a fixed switching frequency and use push-pull converter topology.

For maximum regulation, the remote sensing terminals can be connected to the load. This will allow a power cable voltage drop of up to 0.3 V on each cable to be offset.

The device is protected against overload and short-circuits by means of a current limiting circuit.

The device is also protected against reverse polarity input voltage, and the input fuse blows if an improper connection is made.

When a converter input undervoltage condition occurs, the converter is disabled, thus preventing the battery from becoming totally discharged.

INSTALLATION

There are two connecting options:

- DIN-41612-H15 connector
- Spring clamp terminals.

The product can be mounted in several ways:

- On a chassis by means of the 4 corner holes.
- In EUROCARD racks. For this application there is a standard 9Te front plate accessory reference **NP-9155**

With the base reference **NP-9124**. This accessory can be mounted on a chassis or in DIN rail adding the clip accessory **NP-9135**.

START-UP

Perform connection as per the table. Use of remote sensing is not absolutely necessary, but if this is required, use of a coaxial or a twisted-pair cable is recommended.

WARNING: If the load is connected to the tabs of remote sensing (+/-S) and the connection from the output to this load is missing the remote sensing function could make unusable due to the acting of the internal fuse of protection.

If power levels close to the maximum output are required, make sure the assembly enhances cooling by natural convection and the card is placed in vertical position.

If several converters need to be connected in parallel, do the following:

Set the output voltage for all converters featuring a mutual difference as small as possible.

Join the load outputs by using cables with a cross-section no greater than the one required and of equal length.

Do not use remote sensing.

For safety reasons, the following requirements must be complied with:

Provide the equipment with some kind of protective enclosure that complies with the electrical safety directives in effect within the country where the equipment is installed.

Only replace the fuse with another fuse of the same rating and type, and only after disconnecting the converter from DC power.

DIMENSIONS

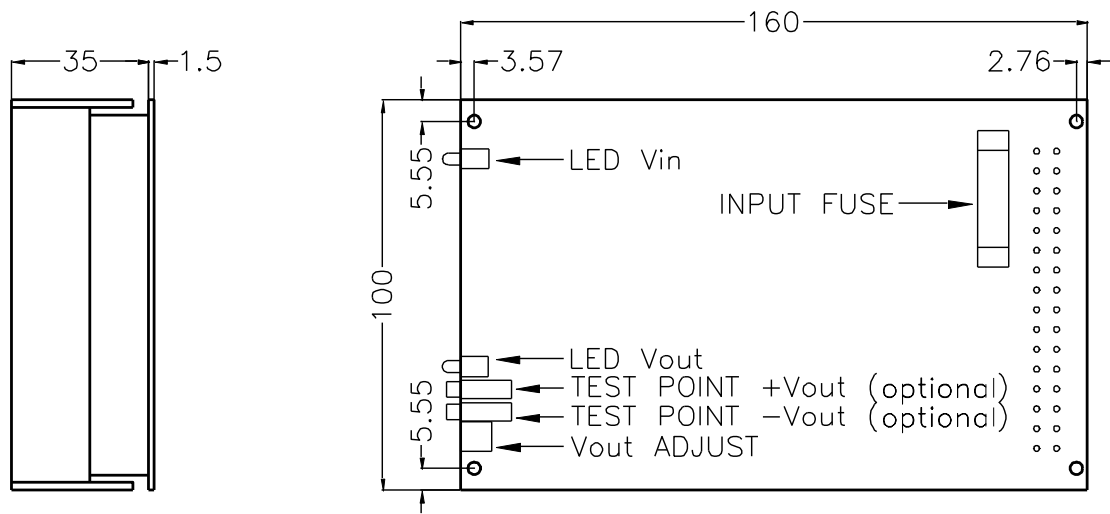

ACCESSORIES

ACCESSORIES	CODE
Rack 19" frontal panel (3U 9TE)	NP-9155
Mounting base	NP-9124
Din rail clip for mounting base	NP-9135
Redundant connection for two units (ORing diodes + alarms contacts)	ACD-15, ACD-25

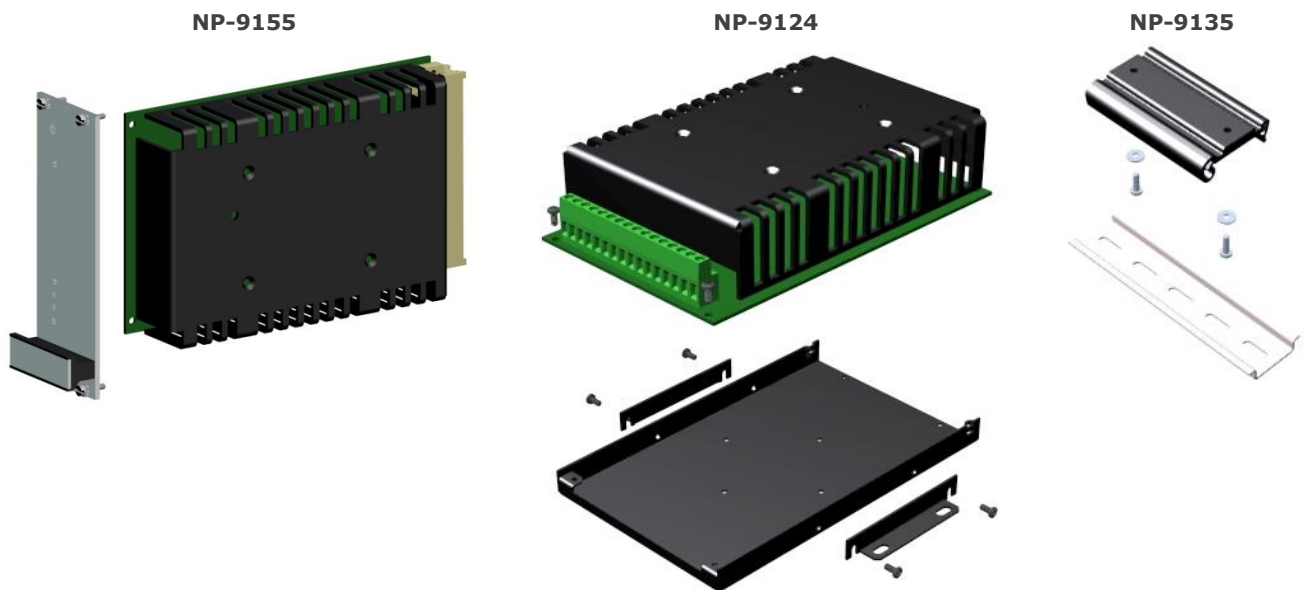



CE EU DECLARATION OF CONFORMITY

The undersigned, representing the following:

Manufacturer: PREMIUM, S. A.,
Address: C/ Dolors Aleu 19-21, 08908 L'Hospitalet de Llobregat, SPAIN

herewith declares that the product:

Type: DC/DC converter
Models: **CRS-120-6761... 6784**

is in conformity with the provisions of the following EU directive(s):

2014/35/EU	Low voltage
2014/30/EU	Electromagnetic compatibility
2011/65/EU	Restriction of the use of certain hazardous substances in electrical and electronic equipment (RoHS)

and that standards and/or technical specifications referenced overleaf have been applied:

EN 60950-1: 2005	Safety. Information technology equipment
EN 62368-1: 2014	Safety. Audio/video, information and communication technology equipment
EN 61000-6-3: 2007	Generic emission standard
EN 61000-6-2: 2005	Generic immunity standard

CE marking year: **2006**

Notes:

For the fulfillment of this declaration the product must be used only for the aim that has been conceived, considering the limitations established in the instructions manual or datasheet.

L'Hospitalet de Llobregat, 28-08-2019

Jordi Gazo
Chief Executive Officer

PREMIUM S.A. is an ISO9001 and ISO14001
certified company by **Bureau Veritas**