

ODX-1300

1300VA DC/AC INVERTER

GENERAL FEATURES:

- Sine wave output voltage
- Suitable for motors control
- Adjustable output voltage
- High input-output isolation 3000Vrms
- Remote control via RS232
- Alarm by isolated relay contacts
- Remote ON/OFF opto-coupled
- According to the standard EN50155
- Fire and smoke: EN45545-2 approved



	24Vdc 16.8 ... 30V	72Vdc 50.4 ... 90V	110Vdc 77 ... 138V
250Vac	ODX-1300-7442* 1300 VA	ODX-1300-7445 1300 VA	ODX-1300-7447 1300 VA
400Vac	ODX-1300-7452 1300 VA	ODX-1300-7455 1300 VA	ODX-1300-7457 1300 VA

Several references are subjected to special MOQs and lead times. Please consult Premium's Sales Dept. and web site.

**INPUT**

Input voltage range	-30, +25% Vin nom
Maximum input ripple	5% Vin nom (Vrms, 100Hz)
Inrush current	<25A
Polarity protection	By diode

OUTPUT

Nominal output voltage (Von)	See table (ordering codes)
Output voltage range	150 ... 250V (models of 250V output) via RS-232 200 ... 400V (models of 400V output) via RS-232
Output frequency range	5...60Hz via RS-232
Load regulation	< 4%
Line regulation	< 2% Vin -25% ... +25%, < 10% Vin -30% ... +30%
Output wave distortion THD	< 3% (average of 16 samples)
Output HF ripple	< 2.5%

ENVIRONMENTAL

Storage temperature	-25 ... 85°C
Operating temperature:	
Full load	-25 ... 55°C (EN50155 OT1)
62.5% load	-25 ... 70°C (EN50155 OT3)
25% load	-25 ... 85°C (EN50155 OT5)
Relative humidity without condensation	5 ... 95%
Cooling	Controlled internal fan
MTBF (MIL-HDBK-217-E; G _b , 25°C)	100.000 h

EMC

Immunity according	EN61000-6-2, EN50121-3-2
Emissions according	EN61000-6-4, EN50121-3-2

SAFETY

Dielectric strength: Input /output	3000 Vrms / 50Hz / 1min
Dielectric strength: Output / Earth	1500 Vrms / 50Hz / 1min
Dielectric strength: Input / Earth	1500 Vrms / 50Hz / 1min
Dielectric strength: Remote ON/OFF / Input	500 Vrms / 50Hz / 1min
Safety according to	EN60950-1, EN62368-1
Fire and smoke	EN45545-2

MECHANICAL

Weight	<3200 g
--------	---------

PROTECTIONS

Against overloads and short-circuits	Shutdown with auto-recovery (see working parameters)
Against over-temperature	Shutdown with auto-recovery

CONTROL

Output alarm	Open when alarm. Maximum rating: 0.16A at 160Vdc
Remote ON/OFF input	ON applying a voltage within the input voltage range OFF open circuit or < 5V



ORDERING CODES

Model	Input				Output					Effic.	Size
	Voltage		Current		Power		Voltage	Current			
	Nom.	Range	Max.	No load	Active	Appar.	Nom.	Nom.	Iopk 10ms	Nom.	
	[V]	[V]	[A]	[A]	[W]	[VA]	[V]	[A]	[A]	[%]	
ODX-1300-7442	24	16.8 - 30	73.57	<1.58	1100	1300	250	3.10	6.6	89	2
ODX-1300-7445	72	50.4 - 90	24.25	<0.52	1100	1300	250	3.10	6.6	90	1
ODX-1300-7447	110	77 - 138	15.87	<0.34	1100	1300	250	3.10	6.6	90	1
ODX-1300-7452	24	16.8 - 30	73.57	<1.58	1100	1300	400	1.88	3.4	89	2
ODX-1300-7455	72	50.4 - 90	24.25	<0.52	1100	1300	400	1.88	3.4	90	1
ODX-1300-7457	110	77 - 138	15.70	<0.34	1100	1300	400	1.88	3.4	91	1

Several references are subjected to special MOQs and lead times. Please consult Premium's Sales Dept. and web site.



BLOCKS DIAGRAM

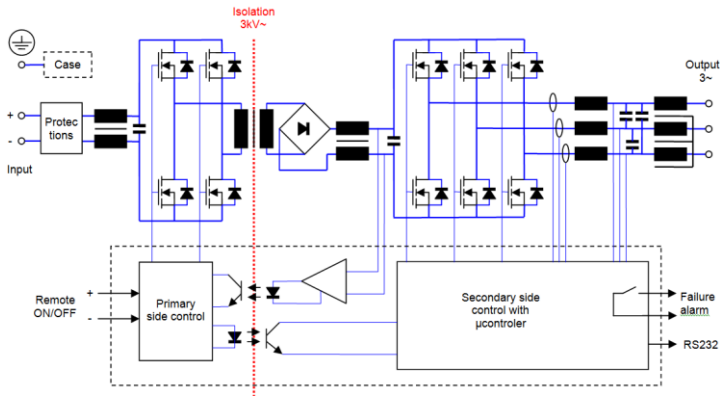

RS232 Monitoring	RS232 Settings
Output voltage	On / Off
Internal temperature	Output voltage
Output frequency	Output frequency
Inverter state	Reset
Model number	
Firmware version	

CONNECTIONS

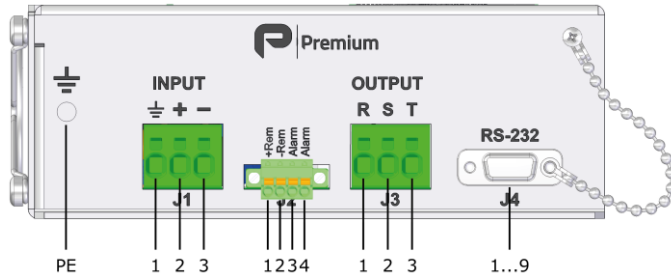

J0	Case PE	Threaded shank M6 (Rec. torque 3.8 Nm)
J1-1	Protective Earth	Cable 1.5...16mm ²
J1-2	+Input	
J1-3	-Input	
J2-1	+Remote off	Phoenix Contact MC1.5/4-GF-3.81 Mating connector included
J2-2	-Remote off	
J2-3	Alarm	
J2-4	Alarm	
J3-1	R Output	Cable 0.75...4mm ²
J3-2	S Output	
J3-3	T Output	
J4-2	RS232 Rx	SUB DB9
J4-3	RS232 Tx	
J4-5	RS232 GND	

DESCRIPTION

The ODX-1300 consists of three phase sine-wave DC-AC inverters with galvanic isolation between input and output.

The unit allows:

- Start-up motors by means of a soft start. In the start-up, the output voltage and frequency rise linearly from 0V to set voltage and from 5Hz to set frequency. The start-up ramp slope may be changed via RS-232 port
- Set the rotation speed of a motor according to the appropriate Voltage/Frequency ratio.
- Monitoring the status of the input and output.
- Set and monitor parameters via RS-232.

The ODX-1300 has a maximum output current protection. This protects the semiconductors even when an output short-circuit occurs. It also features a disable function for input under-voltage.

INSTALLATION

- The unit has 4 threaded holes for the fixation on a mounting surface.
- The unit has internal fans. For an appropriate cooling, the air input and output should be free of elements that cause and an air flow reduction (minimum recommended distance to other objects 50mm).
- Make connections as shown in the figure
- To start up the unit without a remote ON/OFF signal, it is possible by configuring the unit via RS232 port or by making the following connection

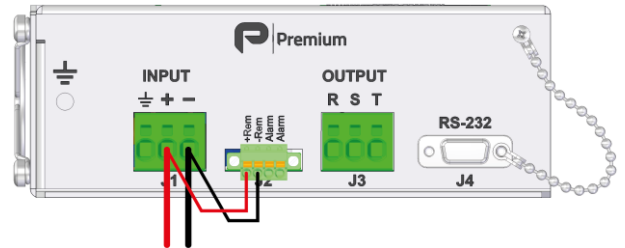

For safety reasons, the following requirements must be met:

- Provide the equipment with some kind of protective enclosure that complies with the electrical safety directives in effect within the country where the equipment is installed.
- Include an input fuse with a rating immediately higher than the maximum input current.
- Use cables of adequate cross-section to connect inputs and outputs. The following table lists the maximum currents and the minimum cross-sections for the cables used for each power connection.

	Input 24V	Input 72V	Input 110V	Output 250V	Output 400V
Current	70A	24.4A	16 A	3.1A	1.88A
Cable cross section	16 m ²	2.5 mm ²	1.5 mm ²	0.75 mm ²	0.75 mm ²

POWER DERATING vs AMBIENT TEMP.

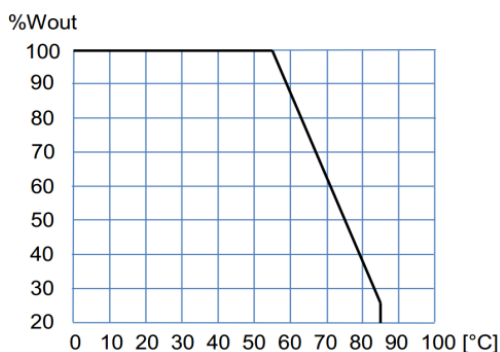

RS232 communication port

It is possible to control and monitor the unit via RS232 by means a terminal emulator like "Tera Term" or "Putty"
Also it is possible to control and monitor the unit directly using the protocol showed in table:

Protocol configuration: ASCII code, 9600 bauds, parity none, 8 bits, 1bit stop

Header	Function	Parameter	Returns	Description	
P	L	U	PTU####.n	Output voltage in Volts RMS	
		T	PTT####.n	Internal temperature in °C	
		F	PTF####.n	Output frequency in Hz	
		S	PTS####.n	Inverter status 999.9 → Enabled 000.0 → Disabled 111.1 → Inverter blocked by overload or short-circuit	
		M	PTM####	Model number	
		R	PTR####	Firmware version	
		Other character	PTE	Command not supported	
	R	G	3	####.n	OK / ERR Changes the inverter status 999.9 → Enabled 000.0 → Disabled
			4	####.n	OK / ERR Set the output voltage in Volts RMS 150.0 ≤ ####.n ≤ 250.0 (models of 250V output) 200.0 ≤ ####.n ≤ 400.0 (models of 400V output)
			6	####.n	OK / ERR Changes the output frequency in Hz (output must be stopped) 005.0 ≤ ####.n ≤ 075.0 Factory preconfigured → 50 Hz
			8	####.n	OK / ERR 111.1 → Reset the inverter
			B	####.n	OK / ERR Changes the logic of the 'Remote OFF input' 222.2 → Inverter On applying 15...143Vdc on 'Remote OFF input' 111.1 → Inverter Off applying 15...143Vdc on 'Remote OFF input'
			O	####.n	OK / ERR Set the initial frequency in the start-up (Fi) (output must be stopped) 005.0 ≤ ####.n ≤ 075.0 Factory preconfigured → 16Hz
			P	####.n	OK / ERR Set the ramp-up in increment of "N" cycles per Hz in mode V/F, frequency changes or start-up (Note-1) 001.0 ≤ ####.n ≤ 100.0

Note: **OK** (Data accepted) / **ERR** (Data not valid for the current parameter)

Note 1:

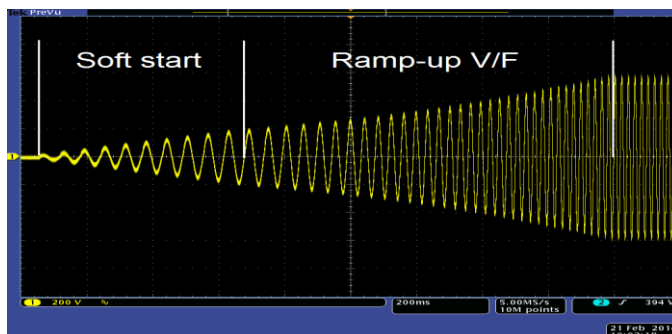

Example for N=1: start-up time = N x 1.7s for changes from 16Hz to 50Hz

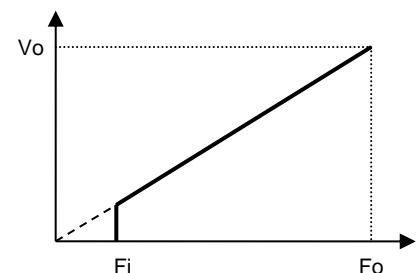

Mode V/F curve

**DEFAULT WORKING PARAMETERS**

Thermal protection	7442 ... 7457			
Internal shutdown temperature	87			°C
Internal restart temperature	82			°C
Internal temperature of fan start-up	45			°C
Input voltage parameters	74X2	74X5	74X7	
<u>Low input voltage timed shutdown (t)</u> (Input alarm)	16.8	50.4	77.0	Vdc
Low input voltage instantaneous shutdown	14.4	43.2	66.0	Vdc
Time to shutdown (t)	500			ms
Output voltage parameters	744X	745X		
<u>Output frequency</u>	60	50		Hz
<u>Output voltage</u>	208	400		Vac
Output under-voltage shutdown	< 85% of setting 1000ms			
Warning voltage (output alarm)	< 90% of setting 200ms			
<u>Initial start-up frequency</u>	5			Hz
Soft start duration	10 cycles			
Ramp-up V/F	1 Hz/cycle			
Output current parameters	744X	745X		
<u>Maximum continuous output current</u>	3.10	1.88		A
Time between restart attempts	4000			ms
Number of attempts of consecutive overload	3			
Working failures and reset	7442 ... 7457			
Lock for continuous overload or internal failure	Unlimited time			
Reset time by input disconnection	>2			min

Configurable parameters underlined



DIMENSIONS

SIZE-1

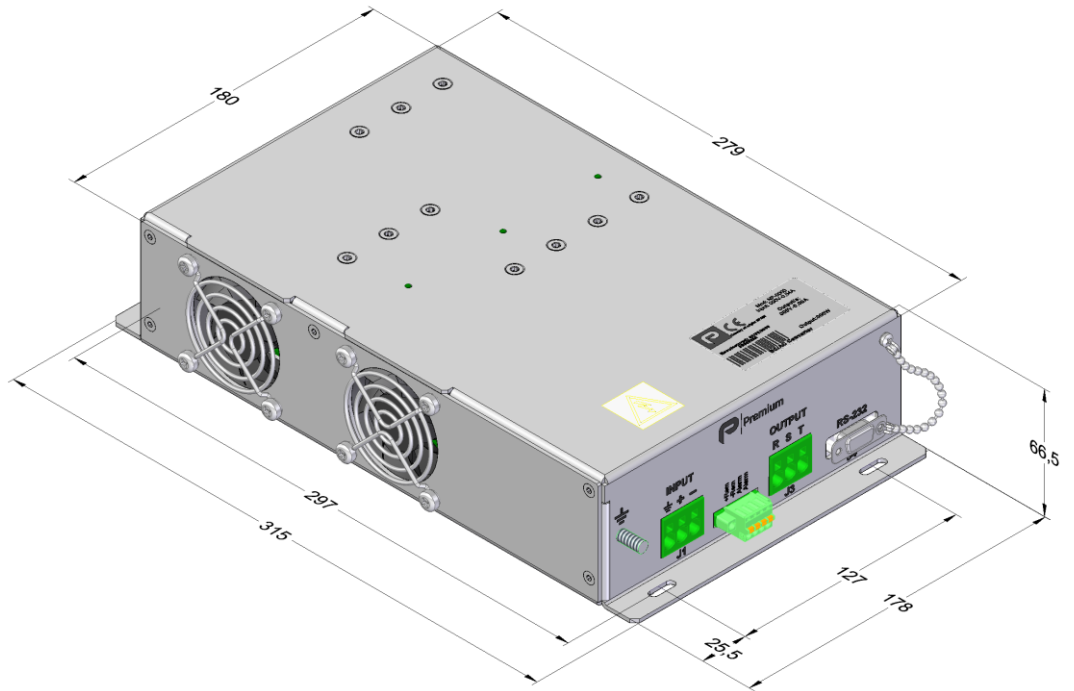

SIZE-2

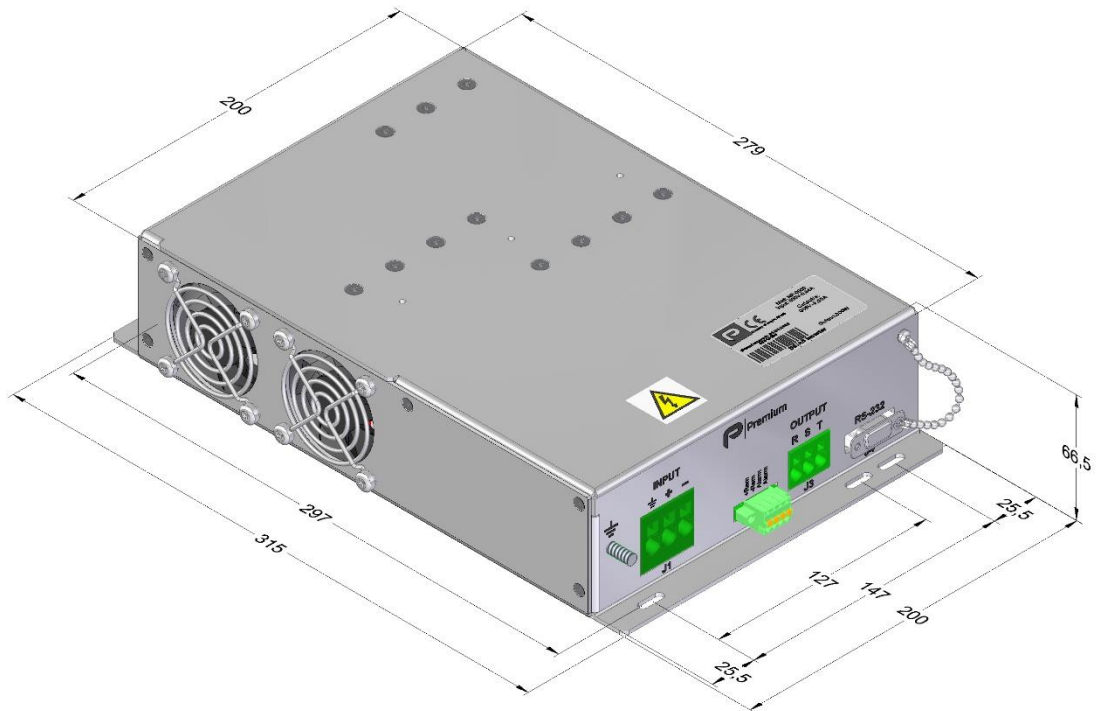



CE EU DECLARATION OF CONFORMITY

The undersigned, representing the following:

Manufacturer: PREMIUM, S. A.,
Address: C/ Dolors Aleu 19-21, 08908 L'Hospitalet de Llobregat, SPAIN

herewith declares that the product:

Type: **DC/AC Inverter**
Brand: **Premium**
Models: **ODX-1300-7442, ODX-1300-7445, ODX-1300-7447,
ODX-1300-7452, ODX-1300-7455, ODX-1300-7457**

is in conformity with the provisions of the following EU directive(s):

2014/35/EU	Low voltage / The electrical equipment (safety) regulations
2014/30/EU	EMC / Electromagnetic compatibility regulations
2011/65/EU Annex II and its amendment 2015/863/EU	RoHS / Restriction of the use of certain hazardous substances in electrical and electronic equipment

This declaration applies to all specimens manufactured identical to the samples submitted for testing/evaluation.

Assessment of compliance of the product with the requirements relating to aforementioned directives, was performed by Premium S.A. and is based on the following standards:

EN IEC62368-1:2024 A11:2024	Safety. Audio/video information and communication technology equipment
EN IEC61000-6-4:2019	Generic emission standard
EN IEC61000-6-2:2019	Generic Immunity standard
EN IEC63000:2018	Technical documentation for the assessment of electrical and electronic products with respect to the restriction of hazardous substances
EN50155: 2021*	Railway applications. Electronic equipment used on rolling stock material
EN50121-3-2: 2016* A1:2019	Railway applications. EMC Rolling stock equipment

* Optional, see annexe

CE marking year: **2017**

Notes:

For the fulfilment of this declaration the product must be used only for the aim that has been conceived, considering the limitations established in the instructions manual or datasheet.

L'Hospitalet de Llobregat, 19-03-2025

Manuel Camacho
Technical Director

PREMIUM S.A. is an ISO9001 and ISO14001
certified company by **Bureau Veritas**



**UK
CA** UKCA DECLARATION OF CONFORMITY

The undersigned, representing the following:

Manufacturer: PREMIUM, S. A.,

Address: C/. Dolors Aleu 19-21, 08908 L'Hospitalet de Llobregat, SPAIN

herewith declares that the products:

Type: **DC/AC Inverter**

Brand: **Premium**

Models: **ODX-1300-7442, ODX-1300-7445, ODX-1300-7447,
ODX-1300-7452, ODX-1300-7455, ODX-1300-7457**

Complies with the essential protection requirements of the following regulations:

SI 2016 No 1101	Low voltage / The electrical equipment (safety) regulations
SI 2016 No 1091	EMC / Electromagnetic compatibility regulations
SI 2012 No. 3032	RoHS / Restriction of the use of certain hazardous substances in electrical and electronic equipment

This declaration applies to all specimens manufactured identical to the samples submitted for testing/evaluation.

Assessment of compliance of the product with the requirements relating to aforementioned regulations, was performed by Premium S.A. and is based on the following standards:

EN IEC62368-1:2024 + A11:2024	Safety. Audio/video information and communication technology equipment
EN IEC61000-6-4:2019	Generic emission standard
EN IEC61000-6-2:2019	Generic Immunity standard
EN IEC63000:2018	Technical documentation for the assessment of electrical and electronic products with respect to the restriction of hazardous substances
EN50155: 2021*	Railway applications. Electronic equipment used on rolling stock material
EN50121-3-2: 2016* +A1:2019	Railway applications. EMC Rolling stock equipment

* Optional, see annexe

UKCA marking year: **2021**

Notes:

For the fulfilment of this declaration the product must be used only for the aim that has been conceived, considering the limitations established in the instructions manual or datasheet.

L'Hospitalet de Llobregat, 19-03-2025

Manuel Camacho
Technical Director

PREMIUM S.A. is an ISO9001 and ISO14001
certified company by **Bureau Veritas**

ANNEXE

Applicable values for the different sections of the norm EN50155: 2021																																																														
4.4.1	Working altitude	Up to 2000m																																																												
4.4.2	Ambient temperature	Class OT1 (-25 to 55°C): load < 100% Class OT3 (-25 to 70°C): load <62.5%																																																												
4.4.3	Switch-on extended operating temp.	ST1: OTx + 15 °C, test cycle B																																																												
4.4.4	Rapid temperature variations	H1																																																												
4.4.5	Shocks and vibrations	According EN61373:2010 Category 1 class B																																																												
4.4.6	EMC Electromagnetic Compatibility EN50121-3-2:2016 A1:2019	<table border="1"> <thead> <tr> <th colspan="5">Emissions</th> </tr> <tr> <th>Test</th> <th>Norm</th> <th>Port</th> <th>Frequency</th> <th>Limits</th> </tr> </thead> <tbody> <tr> <td rowspan="4">Radiated emissions</td> <td rowspan="4">IEC55016</td> <td rowspan="4">Case</td> <td>30MHz...230MHz</td> <td>40dB(µV/m) Qpk at 10m</td> </tr> <tr> <td>230MHz...1GHz</td> <td>47dB(µV/m) Qpk at 10m</td> </tr> <tr> <td>1...3GHz</td> <td>Do not apply</td> </tr> <tr> <td>3...6GHz</td> <td>Internal freq. < 108MHz</td> </tr> <tr> <td rowspan="2">Conducted emissions</td> <td rowspan="2">IEC55016</td> <td rowspan="2">Input</td> <td>150kHz...500kHz</td> <td>99dB(µV) Qpk</td> </tr> <tr> <td>500kHz...30MHz</td> <td>93dB(µV) Qpk</td> </tr> </tbody> </table>	Emissions					Test	Norm	Port	Frequency	Limits	Radiated emissions	IEC55016	Case	30MHz...230MHz	40dB(µV/m) Qpk at 10m	230MHz...1GHz	47dB(µV/m) Qpk at 10m	1...3GHz	Do not apply	3...6GHz	Internal freq. < 108MHz	Conducted emissions	IEC55016	Input	150kHz...500kHz	99dB(µV) Qpk	500kHz...30MHz	93dB(µV) Qpk																																
		Emissions																																																												
		Test	Norm	Port	Frequency	Limits																																																								
		Radiated emissions	IEC55016	Case	30MHz...230MHz	40dB(µV/m) Qpk at 10m																																																								
					230MHz...1GHz	47dB(µV/m) Qpk at 10m																																																								
					1...3GHz	Do not apply																																																								
					3...6GHz	Internal freq. < 108MHz																																																								
		Conducted emissions	IEC55016	Input	150kHz...500kHz	99dB(µV) Qpk																																																								
					500kHz...30MHz	93dB(µV) Qpk																																																								
		<table border="1"> <thead> <tr> <th colspan="6">Immunity</th> </tr> <tr> <th>Test</th> <th>Norm</th> <th>Port</th> <th>Severity</th> <th>Conditions</th> <th>P</th> </tr> </thead> <tbody> <tr> <td rowspan="2">Electrostatic discharge</td> <td rowspan="2">IEC61000-4-2</td> <td rowspan="2">Case</td> <td>±8kV</td> <td>Air (isolated parts)</td> <td rowspan="2">B</td> </tr> <tr> <td>±8kV</td> <td>Contact (conductive parts)</td> </tr> <tr> <td rowspan="4">Radiated high-frequency</td> <td rowspan="4">IEC61000-4-3</td> <td rowspan="4">X/Y/Z Axis</td> <td>20V/m</td> <td>0.08...1.0GHz M. 80% 1kHz</td> <td rowspan="4">A</td> </tr> <tr> <td>10V/m</td> <td>1.4...2.1GHz M. 80% 1kHz</td> </tr> <tr> <td>5V/m</td> <td>2.1...2.5GHz M. 80% 1kHz</td> </tr> <tr> <td>3V/m</td> <td>5.1...6Ghz M. 80% 1kHz</td> </tr> <tr> <td rowspan="3">Fast transients</td> <td rowspan="3">IEC61000-4-4</td> <td>Input</td> <td rowspan="3">±2kV</td> <td rowspan="3">Tr/Th: 5/50 ns</td> <td rowspan="3">A</td> </tr> <tr> <td>Output</td> </tr> <tr> <td>Signal</td> </tr> <tr> <td rowspan="2">Surge</td> <td rowspan="2">IEC61000-4-5</td> <td>PE</td> <td>±1kV</td> <td rowspan="2">Tr/Th: 1.2/50µs</td> <td rowspan="2">B</td> </tr> <tr> <td>Input L to L</td> <td>±1kV</td> </tr> <tr> <td rowspan="4">Conducted RF</td> <td rowspan="4">IEC61000-4-6</td> <td>Input L to PE</td> <td>±2kV</td> <td rowspan="4">0.15...80MHz M. 80% 1kHz</td> <td rowspan="4">A</td> </tr> <tr> <td>Input</td> <td rowspan="3">10V</td> </tr> <tr> <td>Output</td> </tr> <tr> <td>Signal</td> </tr> <tr> <td>PE</td> <td></td> </tr> </tbody> </table>	Immunity						Test	Norm	Port	Severity	Conditions	P	Electrostatic discharge	IEC61000-4-2	Case	±8kV	Air (isolated parts)	B	±8kV	Contact (conductive parts)	Radiated high-frequency	IEC61000-4-3	X/Y/Z Axis	20V/m	0.08...1.0GHz M. 80% 1kHz	A	10V/m	1.4...2.1GHz M. 80% 1kHz	5V/m	2.1...2.5GHz M. 80% 1kHz	3V/m	5.1...6Ghz M. 80% 1kHz	Fast transients	IEC61000-4-4	Input	±2kV	Tr/Th: 5/50 ns	A	Output	Signal	Surge	IEC61000-4-5	PE	±1kV	Tr/Th: 1.2/50µs	B	Input L to L	±1kV	Conducted RF	IEC61000-4-6	Input L to PE	±2kV	0.15...80MHz M. 80% 1kHz	A	Input	10V	Output	Signal	PE	
		Immunity																																																												
		Test	Norm	Port	Severity	Conditions	P																																																							
		Electrostatic discharge	IEC61000-4-2	Case	±8kV	Air (isolated parts)	B																																																							
					±8kV	Contact (conductive parts)																																																								
		Radiated high-frequency	IEC61000-4-3	X/Y/Z Axis	20V/m	0.08...1.0GHz M. 80% 1kHz	A																																																							
10V/m	1.4...2.1GHz M. 80% 1kHz																																																													
5V/m	2.1...2.5GHz M. 80% 1kHz																																																													
3V/m	5.1...6Ghz M. 80% 1kHz																																																													
Fast transients	IEC61000-4-4	Input	±2kV	Tr/Th: 5/50 ns	A																																																									
		Output																																																												
		Signal																																																												
Surge	IEC61000-4-5	PE	±1kV	Tr/Th: 1.2/50µs	B																																																									
		Input L to L	±1kV																																																											
Conducted RF	IEC61000-4-6	Input L to PE	±2kV	0.15...80MHz M. 80% 1kHz	A																																																									
		Input	10V																																																											
		Output																																																												
		Signal																																																												
PE																																																														
P = Performance criteria, L= Line, PE= Protective Earth																																																														
4.4.7	Relative humidity	Up to 95%																																																												
5.2.2	DC power supply range	From 0.60 to 0.70 Un 0.1s	Performance criteria A																																																											
		From 0.70 to 1.25 Un continuous	Performance criteria A																																																											
		From 1.25 to 1.40 Un 0.1s	Performance criteria A																																																											
		From 1.25 to 1.40 Un 1s	Performance criteria C																																																											
5.2.4	Interruptions of voltage supply	Class S2																																																												
5.2.5	Supply change-over	Class C1 (0.6 Un duration 100ms without interruptions. Performance criterion A)																																																												
5.2.7	Input ripple factor	10% peak to peak with a DC Ripple Factor of 5 %																																																												
7.2.7	Input reverse polarity protection	By fuse																																																												
10.7	Protective coating for PCB assemblies	Class PC2																																																												
13.3	Tests list	<table border="0"> <tr><td>1</td><td>Visual Inspection</td><td>Routine</td></tr> <tr><td>2</td><td>Performance test</td><td>Routine</td></tr> <tr><td>3</td><td>Power supply test</td><td>Type</td></tr> <tr><td>4</td><td>Low temperature start-up test</td><td>Type</td></tr> <tr><td>5</td><td>Dry heat test</td><td>Type</td></tr> <tr><td>6</td><td>Low temperature storage test</td><td>-</td></tr> <tr><td>7</td><td>Insulation test</td><td>Routine</td></tr> <tr><td>8</td><td>Cyclic damp heat test</td><td>Type</td></tr> <tr><td>9</td><td>EMC test</td><td>Type</td></tr> <tr><td>10</td><td>Shocks and vibrations test</td><td>Type</td></tr> <tr><td>11</td><td>Enclosure protection test (IP code)</td><td>-</td></tr> <tr><td>12</td><td>Equipment stress screening test</td><td>Routine: 40°C and load 100%</td></tr> <tr><td>13</td><td>Rapid Temperature variation test</td><td>-</td></tr> <tr><td>14</td><td>Salt mist test</td><td>-</td></tr> </table>	1	Visual Inspection	Routine	2	Performance test	Routine	3	Power supply test	Type	4	Low temperature start-up test	Type	5	Dry heat test	Type	6	Low temperature storage test	-	7	Insulation test	Routine	8	Cyclic damp heat test	Type	9	EMC test	Type	10	Shocks and vibrations test	Type	11	Enclosure protection test (IP code)	-	12	Equipment stress screening test	Routine: 40°C and load 100%	13	Rapid Temperature variation test	-	14	Salt mist test	-																		
1	Visual Inspection	Routine																																																												
2	Performance test	Routine																																																												
3	Power supply test	Type																																																												
4	Low temperature start-up test	Type																																																												
5	Dry heat test	Type																																																												
6	Low temperature storage test	-																																																												
7	Insulation test	Routine																																																												
8	Cyclic damp heat test	Type																																																												
9	EMC test	Type																																																												
10	Shocks and vibrations test	Type																																																												
11	Enclosure protection test (IP code)	-																																																												
12	Equipment stress screening test	Routine: 40°C and load 100%																																																												
13	Rapid Temperature variation test	-																																																												
14	Salt mist test	-																																																												