

# ODX-4500

## 4500VA DC/AC INVERTER

### GENERAL FEATURES:

Sine wave output voltage  
 Suitable for motors control  
 Selectable output frequency: 50/60Hz  
 Adjustable output voltage  
 High input-output isolation 3000Vrms  
 Remote inhibit  
 Configurable input: Reverse or Mid power  
 Remote control via RS232  
 Alarms by isolated relay contacts  
 Remote off opto-coupled  
 Optional railway version EN50155  
 Fire and smoke: EN45545-2 approved



	72Vdc 50.4 ... 90V	100Vdc 70 ... 125V	110Vdc 77 ... 138V
400Vac	<b>ODX-4500-7425</b> 4000 W / 4500 VA	<b>ODX-4500-7426</b> 4000 W / 4500 VA	<b>ODX-4500-7427</b> 4000 W / 4500 VA

**INPUT**

Input voltage range	-30, +25% Vin nom
Maximum input ripple	5% Vin nom (Vrms, 100Hz)

**OUTPUT**

Nominal output voltage (Von)	400 Vac
Output voltage range	50...440Vac via RS-232
Output frequency	50 / 60Hz via DIP-switch, 5...75Hz via RS-232
Load regulation	< 4%
Line regulation	< 2% Vin -25% ... +25%, < 10% Vin -30% ... +30%
Output wave distortion THD	< 2% (average of 16 samples)
Output HF ripple	< 2.5%

**ENVIRONMENTAL**

Storage temperature	-25 ... 80°C
Operating temperature:	
Full load	-25 ... 55°C (EN50155 OT1)
62.5% load	-25 ... 70°C (EN50155 OT3)
25% load	-25 ... 85°C (EN50155 OT5)
Relative humidity without condensation	5 ... 95%
Cooling	Controlled internal fan
MTBF (MIL-HDBK-217-E; G <sub>b</sub> , 25°C)	100.000 h

**EMC**

Immunity according	EN61000-6-2, EN50121-3-2
Emissions according	EN61000-6-4, EN50121-3-2

**SAFETY**

Dielectric strength: Input /output	3000 Vrms / 50Hz / 1min
Dielectric strength: Output / ground	1500 Vrms / 50Hz / 1min
Dielectric strength: Input / ground	500 Vrms / 50Hz / 1min
Safety according to	EN60950-1, EN62368-1
Fire and smoke	EN45545-2 (only for <b>T</b> railway versions)

**MECHANICAL**

Weight	<7240 g
Shock and Vibrations according to	EN61393:2011 Category 1 Class B

**PROTECTIONS**

Against overloads	Current and I <sup>2</sup> T limited (see overload protection)
Against over-temperature	Shutdown with auto-recovery

**CONTROL**

Output OK LED	Green
Input OK LED	Green
Input alarm	Open when alarm. Maximum rating: 0.16A at 160Vdc
Output alarm	Open when alarm. Maximum rating: 0.16A at 160Vdc
Remote OFF input	OFF: applying 15...143Vdc, Impedance>35kΩ
Configurable input (reverse or mid-power)	ON: applying 15...143Vdc, Impedance>35kΩ



## ORDERING CODES

Model	Input voltage DC [V]	Input voltage range [V]	Output voltage AC [V]	Output current [A]	Active output power [W]	Appar. output power [VA]	Output peakcurrent		Efficien. [%]	No load input current [A]
							5s (rms) [A]	(Iopk) 10ms [A]		
<b>ODX-4500-7425</b>	72	50.4 - 90	400	6.50	4000	4500	9.5	15	92	< 0.67
<b>ODX-4500-7426</b>	100	70 - 125	400	6.50	4000	4500	9.5	15	93	< 0.49
<b>ODX-4500-7427</b>	110	77 - 138	400	6.50	4000	4500	9.5	15	93	< 0.44

ODX-4500-74 \_ \_ - \_

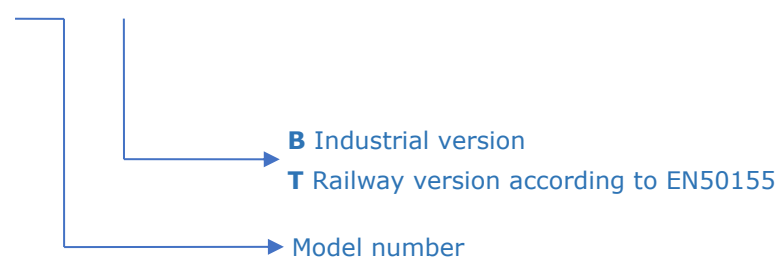

Accessories must be ordered in a separate order line



## BLOCKS DIAGRAM

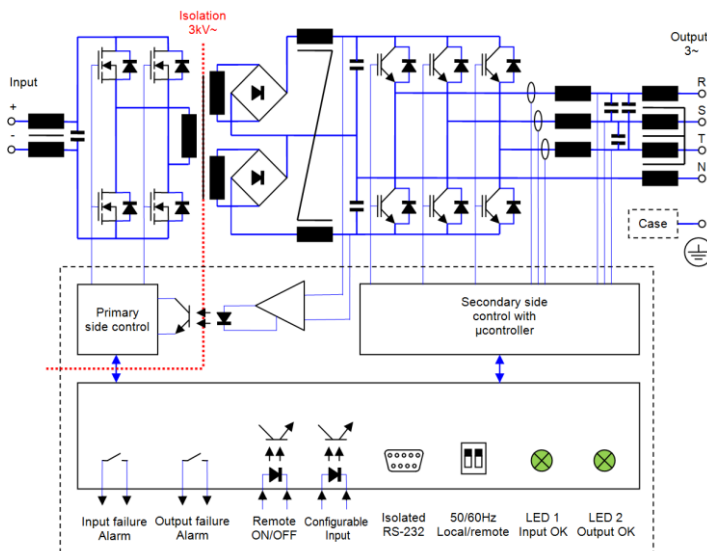

## CONNECTIONS

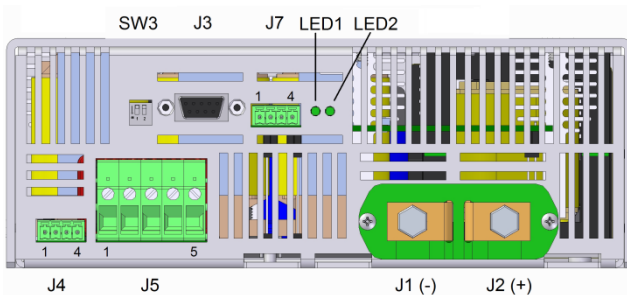

J1	-Vin	Terminals M6
J2	+Vin	
J5 - 1	Protective Earth	Cables 1.5 ... 2.5mm <sup>2</sup>
J5 - 2	Output R	
J5 - 3	Output S	
J5 - 4	Output T	
J5 - 5	Output Neutral	
J4 - 1	+ Configurable input	Phoenix Contact MC1.5/4-G-3.81 Recommended female: Phoenix Contact MC1.5/4-ST-3.81
J4 - 2	- Configurable input	
J4 - 3	+ Remote ON/OFF	
J4 - 4	- Remote ON/OFF	
J7 - 1	Output alarm	Phoenix Contact MC1.5/4-G-3.81 Recommended female: Phoenix Contact MC1.5/4-ST-3.81
J7 - 2	Output alarm	
J7 - 3	Input alarm	
J7 - 4	Input alarm	
J3 - 2	RS-232 Rx	Sub-DB9 female
J3 - 3	RS-232 Tx	
J3 - 5	RS-232 GND	
J3 rest	Not connected	

## POWER DERATING vs AMBIENT TEMP.

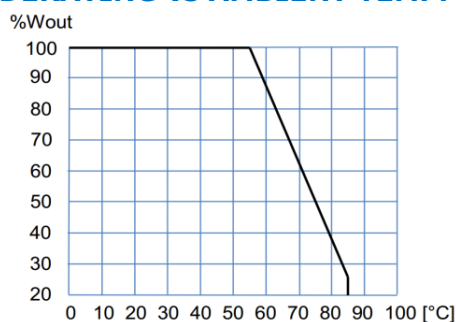

## DESCRIPTION

The ODX-4500 consists of three phase sine-wave DC-AC inverters with galvanic isolation between input and output.

The unit allows:

- Changing the output frequency by means of DIP-switch-1 of SW3. OFF: 50Hz or default programmed, ON: 60Hz
- Change local/remote (waiting RS-232 commands) by means of DIP-switch-2 of SW3. OFF: local, ON: remote
- Shutdown applying voltage output 15 to 143V on pins 3 and 4 of J4
- Start-up motors by means of a soft start. In the start-up, the output voltage rises linearly from 0V to set voltage and the frequency from the initial to the set one. The start-up ramp slope may be changed via RS-232
- Set the rotation speed of a motor according to the appropriate Voltage/Frequency ratio.
- Configurable input (pin 1 and 2 of J4):
  - Reverse mode: Changing the rotation direction for the next start-up of a motor by applying voltage between 15 and 143V
  - Mid power mode: Changing the output frequency in V/F mode from nominal to a mid-power frequency by applying voltage between 15 and 143V.
- Monitoring the status of the input and output voltage through the contacts of two separate solid state relays.
- Set and monitor parameters via RS-232.

The ODX-4500 is equipped with a maximum average power protection as well as maximum output peak current protection. This protects the semiconductors even when an output short-circuit occurs. It also features a disable function for input under-voltage, which allows protecting the batteries from harmful discharges.

## INSTALLATION

- The unit has 4 threaded holes for the fixation on a mounting surface.
- The unit has internal fans. For an appropriate cooling, the air input and output should be free of elements that cause and an air flow reduction (minimum recommended distance to other objects 50mm).
- Make connections as shown in the figure.
- The default output frequency is 50Hz. For 60Hz simply actuate the dip-switch as indicated in the figure.

**For safety reasons, the following requirements must be met:**

- Provide the equipment with some kind of protective enclosure that complies with the electrical safety directives in effect within the country where the equipment is installed.
- Include an input fuse with a rating immediately higher than the maximum input current.
- Use cables of adequate cross-section to connect inputs and outputs. The following table lists the maximum currents and the minimum cross-sections for the cables used for each power connection.

	Input 72V	Input 100V	Input 110V	Output 400V
Maximum current	87 A	62 A	57 A	6.5 A
Cable cross-section	16 mm <sup>2</sup>	16 mm <sup>2</sup>	10 mm <sup>2</sup>	1.5 mm <sup>2</sup>



## RS232 communication port

It is possible to control and monitor the unit via RS232 by means of a terminal emulator like "Tera Term" or "Putty". Also it is possible to control and monitor the unit directly using the protocol showed in table:

**Protocol configuration:** ASCII code, 9600 bauds, parity none, 8 bits, 1bit stop

Header	Function	Parameter	Returns	Explanation	
P	R	V	PTV####	Input voltage in Volts	
		v	PTv####	Input voltage ripple in Volts	
		U	PTURS=####[13]JUST=####[13] UTR=####	Output voltage in Volts RMS ([13]= char 13 of ASCII code)	
		I	PTIR=####[13]IS=####[13] IT=####	Output current in Amps RMS ([13]= char 13 of ASCII code)	
		T	PTT####	Internal temperature in K	
		F	PTF####	Nominal output frequency in Hz	
		f	PTf####	Actual output frequency in Hz	
		u	PTu####	Actual output voltage set-point in V	
		S	PTS####	Inverter state 999.9 → Enabled 000.0 → Disabled 222.2 → Blocked by overload 111.1 → Blocked by overload or short-circuit	
		M	PTM####	Model number	
		R	PTR####	Firmware version	
		Other	PTE	Command not supported	
		G	1	####	OK / ERR
	2		####	OK / ERR	Set the minimum alarm input voltage in V
	3		####	OK / ERR	Change the status bit (after start-up enabled with SW3 =LOCAL and disabled with SW3 =REMOTE) 999.9 → Inverter enabled 000.0 → Inverter disabled
	4		####	OK / ERR	Set the output voltage in Vrms (Vo) (output must be stopped) 050.0 ≤ #### ≤ 440.0
	5		####	OK / ERR	Set the maximum output current in Arms 20% I <sub>nom</sub> ≤ #### ≤ 100% I <sub>nom</sub>
	6		####	OK / ERR	Set the nominal output frequency in Hz (Fo) (output must be stopped) 005.0 ≤ #### ≤ 075.0
	7		####	OK / ERR	Set the alarm maximum output current 0 < #### ≤ 100% I <sub>max_warning</sub>
	8		####	OK / ERR	111.1 → Reset the inverter
	L		####	OK / ERR	Set the minimum input starting voltage in Volts
	O		####	OK / ERR	Set the initial frequency in the start-up (Fi) 005.0 ≤ #### ≤ 075.0
	P		####	OK / ERR	Set the ramp-up in increment of "N" cycles per Hz in mode V/F, frequency changes or start-up (Note-1) 001.0 ≤ #### ≤ 100.0
	Q		####	OK / ERR	Set the ramp-down in decrement of "N" cycles per Hz in mode V/F (Note-1) 002.0 ≤ #### ≤ 100.0
	Y		####	OK / ERR	* Change the working mode of the input J4-1, J4-2 111.1 → Input as reverse phase control (default) 222.2 → Input as mid-power control
	X		####	OK / ERR	* Set the mid-power frequency for V/F mode by the use of input J4-1, J4-2 005.0 ≤ #### ≤ 75.0
	M		1	####	OK / ERR
		2	####	OK / ERR	Set a new output voltage in Volts (output must be run and not stored in memory) 050.0 ≤ #### ≤ 440.0
3		####	OK / ERR	Set a new output frequency in Hz in mode V/F (output must be run and not stored in memory) 005.0 ≤ #### ≤ 075.0	
4		####	OK / ERR	Changes the output phase order 111.1 → Phase RST (direct phase) 222.2 → Phase SRT (reverse phase)	

\*Parameters are only useful from version 6.0 of firmware



Note 1:

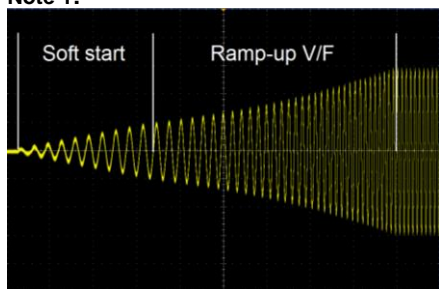

Example for N=1: start-up time = N x 1.7s for changes from 16Hz to 50Hz

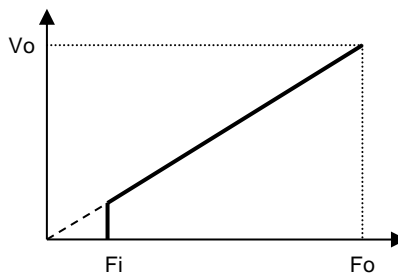

Mode V/F curve

Note 2 :

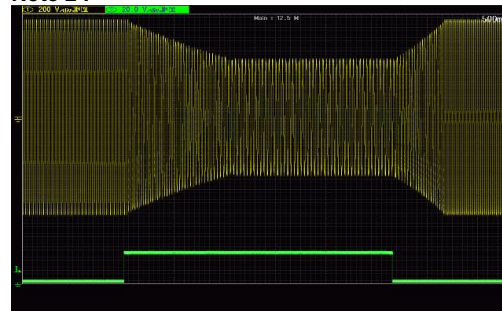

Example for change from 50Hz / 400V to 30Hz and 240V with ramp-down of 2 cycles /Hz and ramp-up de 1 Cycle/Hz. Yellow: output voltage and Green: Mid-Power input signal

## WORKING PARAMETERS

Thermal protection	7425 ... 7427			
Internal warning temperature(output alarm)	88			°C
Internal shutdown temperature	92			°C
Internal restart temperature	75			°C
Internal temperature of fan start-up	45			°C
<b>Input voltage parameters</b>	<b>7425</b>	<b>7426</b>	<b>7427</b>	
High input voltage shutdown instantaneous	100.8	140	154.0	Vdc
High input voltage timed shutdown (t) (Input alarm)	93.6	125.5	143.0	Vdc
<u>Low start-up voltage</u>	57.6	74.5	88.0	Vdc
<u>Low input voltage timed shutdown (t) (Input alarm)</u>	50.4	70.0	77.0	Vdc
Low input voltage instantaneous shutdown	43.2	60.0	66.0	Vdc
Time to shutdown (t)	500			ms
<b>Output voltage parameters</b>	<b>7425 ... 7427</b>			
<u>Output voltage</u>	400			Vac
Output under-voltage shutdown	< 85% of setting 1000ms			
Warning voltage (output alarm)	< 90% of setting 200ms			
<u>Initial start-up frequency</u>	5			Hz
Soft start duration	5 cycles			
<u>Ramp-up V/F</u>	3 cycle / Hz			
<b>Output current parameters</b>	<b>7425 ... 7427</b>			
<u>Maximum continuous output current</u>	6.50			A
<u>Warning current (output alarm)</u>	6.50			A
Maximum overload I <sup>2</sup> t	See figure below			
Time between restart attempts	4000			ms
Number of attempts of consecutive overload	5			
<b>Working failures and reset</b>	<b>7425 ... 7427</b>			
Lock for continuous overload or internal failure	Unlimited time			
Reset time by input disconnection	>1			min

Configurable parameters underlined

## WORKING PARAMETERS OVERLOAD PROTECTION

Protection against overloads and short-circuits	By <b>current</b> limiting at Iopk By <b>I<sup>2</sup>t</b> . The unit shutdowns when the current-time is over the continuous operation curve	
Overload protection recovery	Every 4 seconds after shutdown, the unit tries to restart up to 5 times. If the overload persists, the unit reminds shutdown until an <b>input reconnection</b> .	



## DIMENSIONS

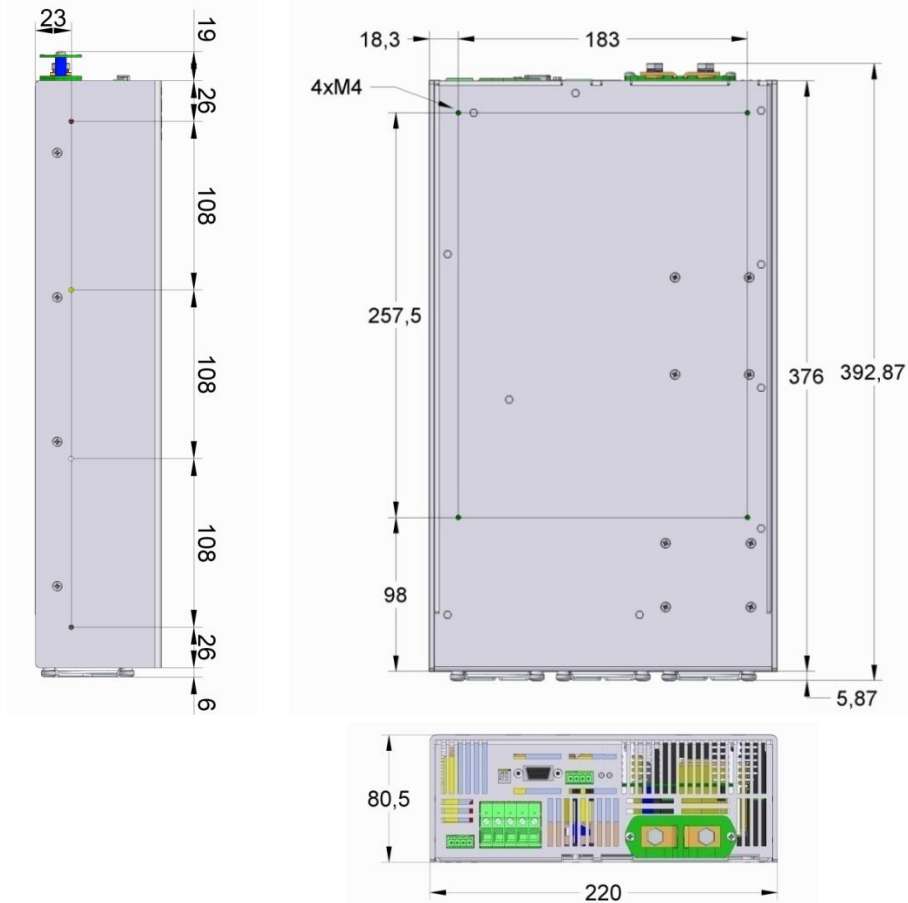

## ACCESSORIES

Description	Notes	CODE
Mounting brackets kit	Contains two brackets and screws	NP-9282
2U 19" rackmount tray kit	It allows to install one or two ODX-4500	NP-9353

### NP-9282

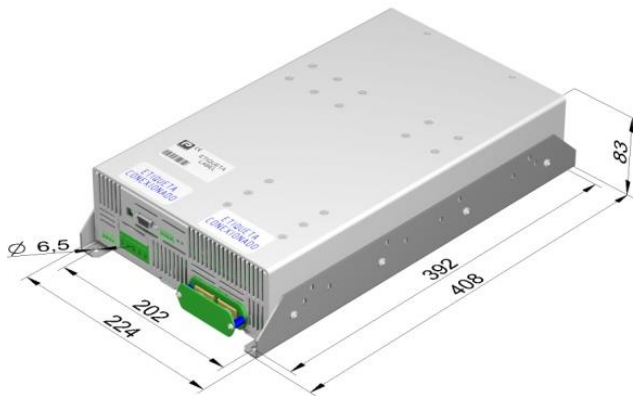

### NP-9353

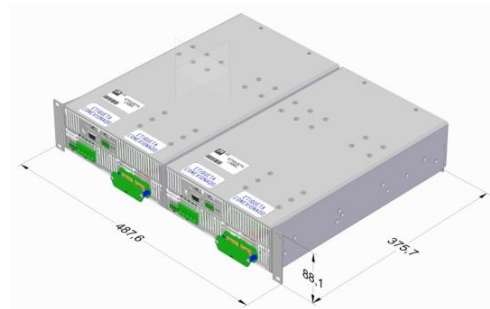
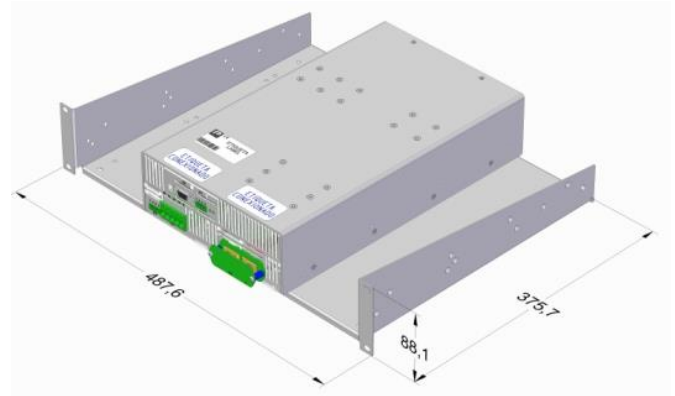



# CE|UK CA EU, UKCA DECLARATION OF CONFORMITY

The undersigned, representing the following:

Manufacturer: PREMIUM, S. A.,  
Address: C/ Dolors Aleu 19-21, 08908 L'Hospitalet de Llobregat, SPAIN

herewith declares that the product:

Type: DC/DC converter  
Models: **ODX-4500-7425 ... 7427**

is in conformity with the provisions of the following EU directive(s):

2014/35/EU SI 2016 No 1101	Low voltage / The electrical equipment (safety) regulations
2014/30/EU SI 2016 No 1091	EMC / Electromagnetic compatibility regulations
2015/863/EU SI 2012 No. 3032	RoHS / Restriction of the use of certain hazardous substances in electrical and electronic equipment

and that standards and/or technical specifications referenced below have been applied:

EN 60950-1: 2005	Safety. Information technology equipment
EN 62368-1: 2014	Safety. Audio/video, information and communication technology equipment
EN 61000-6-3: 2007	Generic emission standard
EN 61000-6-2: 2005	Generic immunity standard
EN 50155: 2017*	Railway applications. Electronic equipment used on rolling stock material
EN 50121-3-2: 2016*	Railway applications. EMC Rolling stock equipment

\* Optional, See annexe

CE marking year: **2017**; UKCA marking year: **2021**

## Notes:

For the fulfilment of this declaration the product must be used only for the aim that has been conceived, considering the limitations established in the instructions manual or datasheet.

L'Hospitalet de Llobregat, 31-05-2021

Albert Sole  
Technical Director

**PREMIUM S.A.** is an ISO9001 and ISO14001  
certified company by **Bureau Veritas**



ANNEXE

Applicable values for the different sections of the norm EN50155: 2017																																																												
4.3.1	Working altitude	Up to 2000m																																																										
4.3.2	Ambient temperature	Class OT1 (-25 to 55°C): load < 100% Class OT3 (-25 to 70°C): load <62.5% Class OT5 (-25 to 85°C): load <25%																																																										
4.3.3	Switch-on extended operating temp.	ST1																																																										
4.3.4	Rapid temperature variations	H1																																																										
4.3.5	Shocks and vibrations	According EN61373:2010 Category 1 class B																																																										
4.3.6	EMC Electromagnetic Compatibility EN50121-3-2:2016	<table border="1"> <thead> <tr> <th>Test</th> <th>Norm</th> <th>Port</th> <th>Frequency</th> <th>Limits</th> </tr> </thead> <tbody> <tr> <td rowspan="3">Radiated emissions</td> <td rowspan="3">IEC55016</td> <td rowspan="3">Case</td> <td>30MHz...230MHz</td> <td>40dB(µV/m) Qpk at 10m</td> </tr> <tr> <td>230MHz...1GHz</td> <td>47dB(µV/m) Qpk at 10m</td> </tr> <tr> <td>1...3GHz 3...6GHz</td> <td>Do not apply Internal freq. &lt; 108MHz</td> </tr> <tr> <td rowspan="2">Conducted emissions</td> <td rowspan="2">IEC55016</td> <td rowspan="2">Input</td> <td>150kHz...500kHz</td> <td>99dB(µV) Qpk</td> </tr> <tr> <td>500kHz...30MHz</td> <td>93dB(µV) Qpk</td> </tr> </tbody> </table>	Test	Norm	Port	Frequency	Limits	Radiated emissions	IEC55016	Case	30MHz...230MHz	40dB(µV/m) Qpk at 10m	230MHz...1GHz	47dB(µV/m) Qpk at 10m	1...3GHz 3...6GHz	Do not apply Internal freq. < 108MHz	Conducted emissions	IEC55016	Input	150kHz...500kHz	99dB(µV) Qpk	500kHz...30MHz	93dB(µV) Qpk																																					
		Test	Norm	Port	Frequency	Limits																																																						
		Radiated emissions	IEC55016	Case	30MHz...230MHz	40dB(µV/m) Qpk at 10m																																																						
					230MHz...1GHz	47dB(µV/m) Qpk at 10m																																																						
					1...3GHz 3...6GHz	Do not apply Internal freq. < 108MHz																																																						
		Conducted emissions	IEC55016	Input	150kHz...500kHz	99dB(µV) Qpk																																																						
					500kHz...30MHz	93dB(µV) Qpk																																																						
		<table border="1"> <thead> <tr> <th>Test</th> <th>Norm</th> <th>Port</th> <th>Severity</th> <th>Conditions</th> <th>P</th> </tr> </thead> <tbody> <tr> <td rowspan="2">Electrostatic discharge</td> <td rowspan="2">IEC61000-4-2</td> <td rowspan="2">Case</td> <td>±8kV</td> <td>Air (isolated parts)</td> <td rowspan="2">B</td> </tr> <tr> <td>±8kV</td> <td>Contact (conductive parts)</td> </tr> <tr> <td rowspan="4">Radiated high-frequency</td> <td rowspan="4">IEC61000-4-3</td> <td rowspan="4">X/Y/Z Axis</td> <td>20V/m</td> <td>0.08...1.0GHz M. 80% 1kHz</td> <td rowspan="4">A</td> </tr> <tr> <td>10V/m</td> <td>1.4...2.1GHz M. 80% 1kHz</td> </tr> <tr> <td>5V/m</td> <td>2.1...2.5GHz M. 80% 1kHz</td> </tr> <tr> <td>3V/m</td> <td>5.1...6Ghz M. 80% 1kHz</td> </tr> <tr> <td rowspan="4">Fast transients</td> <td rowspan="4">IEC61000-4-4</td> <td>Input</td> <td>±2kV</td> <td rowspan="4">Tr/Th: 5/50 ns</td> <td rowspan="4">A</td> </tr> <tr> <td>Output</td> <td>±2kV</td> </tr> <tr> <td>Signal</td> <td>±2kV</td> </tr> <tr> <td>PE</td> <td>±1kV</td> </tr> <tr> <td rowspan="2">Surge</td> <td rowspan="2">IEC61000-4-5</td> <td>Input L to L</td> <td>±1kV</td> <td rowspan="2">Tr/Th: 1.2/50µs</td> <td rowspan="2">B</td> </tr> <tr> <td>Input L to PE</td> <td>±2kV</td> </tr> <tr> <td rowspan="4">Conducted RF</td> <td rowspan="4">IEC61000-4-6</td> <td>Input</td> <td>10V</td> <td rowspan="4">0.15...80MHz M. 80% 1kHz</td> <td rowspan="4">A</td> </tr> <tr> <td>Output</td> <td>10V</td> </tr> <tr> <td>Signal</td> <td>10V</td> </tr> <tr> <td>PE</td> <td>10V</td> </tr> </tbody> </table>	Test	Norm	Port	Severity	Conditions	P	Electrostatic discharge	IEC61000-4-2	Case	±8kV	Air (isolated parts)	B	±8kV	Contact (conductive parts)	Radiated high-frequency	IEC61000-4-3	X/Y/Z Axis	20V/m	0.08...1.0GHz M. 80% 1kHz	A	10V/m	1.4...2.1GHz M. 80% 1kHz	5V/m	2.1...2.5GHz M. 80% 1kHz	3V/m	5.1...6Ghz M. 80% 1kHz	Fast transients	IEC61000-4-4	Input	±2kV	Tr/Th: 5/50 ns	A	Output	±2kV	Signal	±2kV	PE	±1kV	Surge	IEC61000-4-5	Input L to L	±1kV	Tr/Th: 1.2/50µs	B	Input L to PE	±2kV	Conducted RF	IEC61000-4-6	Input	10V	0.15...80MHz M. 80% 1kHz	A	Output	10V	Signal	10V	PE	10V
		Test	Norm	Port	Severity	Conditions	P																																																					
		Electrostatic discharge	IEC61000-4-2	Case	±8kV	Air (isolated parts)	B																																																					
±8kV	Contact (conductive parts)																																																											
Radiated high-frequency	IEC61000-4-3	X/Y/Z Axis	20V/m	0.08...1.0GHz M. 80% 1kHz	A																																																							
			10V/m	1.4...2.1GHz M. 80% 1kHz																																																								
			5V/m	2.1...2.5GHz M. 80% 1kHz																																																								
			3V/m	5.1...6Ghz M. 80% 1kHz																																																								
Fast transients	IEC61000-4-4	Input	±2kV	Tr/Th: 5/50 ns	A																																																							
		Output	±2kV																																																									
		Signal	±2kV																																																									
		PE	±1kV																																																									
Surge	IEC61000-4-5	Input L to L	±1kV	Tr/Th: 1.2/50µs	B																																																							
		Input L to PE	±2kV																																																									
Conducted RF	IEC61000-4-6	Input	10V	0.15...80MHz M. 80% 1kHz	A																																																							
		Output	10V																																																									
		Signal	10V																																																									
		PE	10V																																																									
<b>P</b> = Performance criteria, L= Line, PE= Protective Earth																																																												
4.3.7	Relative humidity	Up to 95%																																																										
5.1.1.2	DC power supply range	From 0.70 to 1.25 Un continuous																																																										
5.1.1.3	Temporary DC power supply fluctuation	From 0.60 to 1.40 Un 0.1s From 1.25 to 1.40 Un 1s without damage																																																										
5.1.1.4	Interruptions of voltage supply	Class S1 (without interruptions)																																																										
5.1.1.6	Input ripple factor	10% peak to peak with a DC Ripple Factor of 5 %																																																										
5.1.3	Supply change-over	0.6 Un duration 100 ms (without interruptions). Performance criterion A																																																										
7.2.7	Input reverse polarity protection	By external fuse																																																										
10.7	Protective coating for PCB assemblies	Class PC2																																																										
13.3	Tests list	1 Visual Inspection 2 Performance test 3 Power supply test 4 Insulation test 5 Low temperature storage test 6 Low temperature start-up test 7 Dry heat test 8 Cyclic damp heat test 9 Salt mist test 10 Enclosure protection test (IP code) 11 EMC test 12 Shocks and vibrations test 13 Equipment stress screening test 14 Rapid Temperature variation test	Routine Routine Routine Routine - Type Type Type - - Type Type Routine: 24h at 40°C and load 100% Type																																																									